

every moment  
is a chance to **do**

SUBARU  
**WRX**  
2019



**SUBARU**



Find out more at [subaru.com.au/wrx-and-wrx-sti](https://www.subaru.com.au/wrx-and-wrx-sti)



# this is your moment

Welcome to Australia's iconic performance vehicle. The thrill of a turbocharged Boxer engine combined with the legendary grip of Symmetrical All-Wheel Drive (AWD), in a distinctively muscular package. The Subaru WRX has grunt, 197kW power and 350Nm torque to be exact.

Every millimetre of the Subaru WRX is built for excitement. A thumping stereo, super large LCD touchscreen, sports body kit, high tech driver assist features and the option of one of the best Lineartronic® CVT automatic transmissions around – this car compromises nothing.

Make every moment more thrilling, more fun and more exciting. Book your test drive today and get behind the wheel of a legend.

Subaru WRX Premium AWD



Subaru WRX AWD

# leave boring behind

No one does performance like we do, and the Subaru WRX AWD is built for pure driving enjoyment. With a stylish and sophisticated interior surrounded by muscle car power and looks, this car oozes attitude.

If the sports mesh grille, 18" alloys, rear spoiler, red brake calipers<sup>1</sup> and bonnet scoop don't command attention, the rumble of the Boxer engine will – delivering 197kW of power and 350Nm@2400-5200rpm of torque.

## Subaru WRX AWD features

### Performance

- + Symmetrical All-Wheel Drive (AWD)
- + 2.0-litre Direct Injection turbocharged horizontally-opposed Boxer engine
- + 6-speed manual transmission or Lineartronic<sup>®</sup> CVT transmission
- + Maximum power output: 197kW@5600rpm
- + Maximum torque: 350Nm@2400-5200rpm

### Interior

- + 60/40 split folding rear seats
- + Air-conditioning – dual zone climate control
- + Cloth seat trim – black
- + Leather steering wheel and gear shift
- + Manual seat height lifter – driver
- + Sports bucket seats – driver and front passenger with red stitching

### Exterior

- + 18" alloy wheels
- + Door mirrors with indicators – heated and power-folding
- + Front fog lights – LED
- + Rain-sensing front wipers
- + Rear fog light
- + Rear spoiler
- + Self-levelling LED headlights with auto off (dusk-sensing)
- + Side sill skirts
- + WRX sports mesh grille

### Entertainment/Technology

- + Auxiliary jack
- + Bluetooth<sup>®2</sup> wireless technology
- + Electronic parking brake (CVT)
- + EyeSight<sup>®</sup> Driver Assist system (CVT) featuring:
  - + Adaptive Cruise Control

- + Brake Light Recognition
- + Lane Departure Warning
- + Lane Keep Assist
- + Lane Sway Warning
- + Lead Vehicle Start Alert
- + Pre-Collision Brake Assist
- + Pre-Collision Braking System
- + Pre-Collision Steering Assist
- + Pre-Collision Throttle Management
- + Integrated infotainment system featuring:
  - + 6.5" LCD touchscreen
  - + Apple CarPlay<sup>®</sup> and Android Auto<sup>™</sup> connectivity<sup>3</sup>
  - + Digital radio<sup>4</sup> (DAB+)
- + Multi-Function Display unit (MFD) with 5.9" LCD touchscreen
- + Rear view reverse camera
- + USB connection
- + Voice command recognition

1. MT – front and rear, CVT – front only. 2. Bluetooth<sup>®</sup> is a registered trademark of Bluetooth SIG Inc. System functionality is subject to the Bluetooth<sup>®</sup> wireless technology specification of individual device. 3. Compatible Apple<sup>®</sup> or Android<sup>™</sup> device required. 4. Digital radio station coverage dependent on vehicle location.

# arrival time? who cares

Just when you thought your ride couldn't get any better, the Subaru WRX Premium AWD delivers an electric sunroof, 8-way power drivers seat, 7" LCD touchscreen and eight thumping Harman Kardon®<sup>1</sup> speakers. The Subaru WRX Premium AWD also boasts Subaru's suite of Vision Assist safety technologies, including Blind Spot Monitor, High Beam Assist, Lane Change Assist and more.

## Subaru WRX Premium AWD features

### Performance

- + Symmetrical All-Wheel Drive (AWD)
- + 2.0-litre Direct Injection turbocharged horizontally-opposed Boxer engine
- + 6-speed manual transmission or Lineartronic® CVT transmission
- + Maximum power output: 197kW@5600rpm
- + Maximum torque: 350Nm@2400-5200rpm

### Interior

- + 60/40 split folding rear seats
- + 8-way power seat with dual memory – driver
- + Air-conditioning – dual zone climate control
- + Auto-dimming rear view mirror
- + Electric lumbar support – driver
- + Heated seats – driver and front passenger
- + Leather<sup>2</sup> seat trim – black
- + Leather steering wheel and gear shift
- + Smart key with push-start ignition
- + Sports bucket seats – driver and front passenger with red stitching

### Exterior

- + 18" alloy wheels
- + Door mirrors with indicators – heated and power-folding
- + Electric sunroof
- + Front fog lights – LED
- + Rain-sensing front wipers with de-icer
- + Rear fog light
- + Rear spoiler
- + Self-levelling LED headlights with auto off (dusk-sensing)
- + WRX sports mesh grille

### Entertainment/Technology

- + 8 Harman Kardon®<sup>1</sup> speakers, subwoofer and amplifier
- + Bluetooth®<sup>3</sup> wireless technology
- + Electronic parking brake (CVT)
- + EyeSight® Driver Assist system (CVT) featuring:
  - + Adaptive Cruise Control
  - + Brake Light Recognition
  - + Lane Departure Warning

- + Lane Keep Assist
- + Lane Sway Warning
- + Lead Vehicle Start Alert
- + Pre-Collision Brake Assist
- + Pre-Collision Braking System
- + Pre-Collision Steering Assist
- + Pre-Collision Throttle Management
- + Integrated infotainment system featuring:
  - + 7" LCD touchscreen
  - + Apple CarPlay® and Android Auto™ connectivity<sup>4</sup>
  - + Digital radio<sup>5</sup> (DAB+)
  - + Satellite navigation
- + Multi-Function Display unit (MFD) with 5.9" LCD touchscreen
- + Rear view reverse camera
- + USB connections (x2)
- + Vision Assist featuring:
  - + Blind Spot Monitor (BSM)
  - + Front View Monitor (FVM)
  - + High Beam Assist (HBA)
  - + Lane Change Assist (LCA)
  - + Rear Cross Traffic Alert (RCTA)
  - + Side View Monitor (SVM)

Arrival time? Who cares.

Explore the range at [subaru.com.au/wrx-and-wrx-sti](http://subaru.com.au/wrx-and-wrx-sti)

1. Harman Kardon® is a registered trademark of HARMAN International Industries, Incorporated. 2. Some parts of the seating or trim are not full natural leather. 3. Bluetooth® is a registered trademark of Bluetooth SIG Inc. System functionality is subject to the Bluetooth® wireless technology specification of individual device. 4. Compatible Apple® or Android™ device required. 5. Digital radio station coverage dependent on vehicle location.



Subaru WRX Premium AWD

# why WRX?

## Symmetrical force of power

### Our All-Wheel Drive philosophy

Greater balance and control. That's the confidence you get from our unique Symmetrical All-Wheel Drive (AWD) system, which delivers the drive distribution to all four wheels, all the time. Every Subaru WRX has an innate sense of balance from the ground up, thanks to a near perfect symmetrical layout.

## Boxing clever

### Our famous Subaru Boxer engine

While most engines stand vertically, ours lay flat. The famous Subaru Boxer engine helps to deliver better handling. Sitting horizontally in the engine bay, it moves like a boxer's fists with a punch and counterpunch action. Lightweight, low and flat, it makes for perfect balance and a much lower centre of gravity. It creates less noise and vibration too. All of this means better on-road handling for you. More stability. More performance. More fun. And a more confident drive.

## DataDotDNA®

Every Subaru is fitted with advanced engine immobilisers and the DataDotDNA®<sup>1</sup> Theft Deterrent System. Microscopic dots are laser-etched with each vehicle's unique Vehicle Identification Number – making it a less attractive target for thieves.

## Three Year Rebate on Theft Insurance Excess

DataDot Technology (Australia) Pty Ltd will pay your theft insurance excess<sup>2</sup> (up to a maximum of \$800 including GST) should your new Subaru be stolen in the first three years of purchase and not recovered within 45 days despite the presence of DataDotDNA®<sup>1</sup> and warning labels.

## Finest safety

### 5 star ANCAP safety across the WRX range

With spirit, quality and imagination comes some serious safety innovation. We want every Subaru WRX to be amongst the safest cars on the road. Engineered full of cutting-edge technologies and the most intelligent design features. The Subaru WRX carries the maximum 5 star ANCAP<sup>3</sup> safety rating.

## Eyes in the back of your head

### Rear view reverse camera

Manoeuvring back into a tight side street? Family driveway littered with toys? Reverse with confidence, thanks to our rear view reverse camera technology. The rear view reverse camera is like having eyes in the back of your head. This greatly improves your visibility and reduces the risk of bumps and scrapes. A rear view reverse camera is standard across the Subaru WRX range.

1. DataDotDNA® is a theft deterrent not a theft prevention mechanism. 2. Vehicles must be registered, comprehensively insured and less than 3 years old. DTA must receive a claim within 45 days of the theft. Terms and conditions apply. 3. The Australasian New Car Assessment Program (ANCAP) gives consumers consistent information on the level of occupant protection provided by vehicles in serious front and side crashes.



## Yet another world first

### Lineartronic® CVT

Pushing innovation beyond the bounds, we introduced an automatic transmission called Lineartronic® Continuously Variable Transmission (CVT). And it's the reason our automatic models drive so smooth. It's the world's first longitudinally mounted system for AWD vehicles. Unlike a conventional automatic transmission – which uses fixed gear ratios – our Lineartronic® CVT provides infinite variability between the highest and lowest available ratios. So you now experience a smoothness that also optimises the efficiency of the vehicle. For even more excitement, switch to manual mode for greater control to suit your driving style. Lineartronic® CVT is available across the Subaru WRX range.

## Intelligently driven

### Subaru Intelligent Drive

Heading to the shops? Taking on the Great Ocean Road? Each situation deserves a distinctive driving mode, so we crafted Subaru Intelligent Drive (SI-Drive) technology standard on all Subaru WRX Lineartronic® CVT variants to do just that. Switch from smart, to sporty to even sportier. Intelligent (I) mode – perfect for everyday driving, Sport (S) mode – for enhanced acceleration and all-round sporty performance and Sport Sharp (S#) mode – for a truly thrilling drive.

## We're looking out for you

### EyeSight® Driver Assist

We were the first car company to exclusively use stereo camera technology to detect objects in our vehicles path. A sign of our future-thinking and our commitment to quality, technology and safety, EyeSight® Driver Assist is like your second pair of eyes, spotting potentially dangerous situations. If EyeSight® detects anything that might be of danger, it warns you audibly, urging you to take action and brake. EyeSight® is standard on Subaru WRX Lineartronic® CVT variants.

## Clever thinking

### Vision Assist

Imagine if your wing mirrors could alert you when there's something in your blind spot. Or if your car could guide you almost perfectly into a parking spot. We made all this happen and more with Subaru's Vision Assist.

Our suite of proactive safety technologies including Blind Spot Monitor, Rear Cross Traffic Alert, Lane Change Assist, High Beam Assist, Front View Monitor and Side View Monitor are always at work to help you feel safer on the road. Subaru's Vision Assist technologies are standard on the Subaru WRX Premium AWD.

# attitude outside, luxury inside

If you're wielding 197kW of muscle car power inside iconic sports styling, you're going to want luxury comfort. The leather steering wheel and gear shift gives you superior feel and control while sports bucket seats hug your body – all trimmed with red stitching. The Subaru WRX Premium AWD also offers heated front seats and black leather<sup>1</sup> trim.

Set the soundtrack and make handsfree calls through the large intuitive LCD touchscreen. A rear view reverse camera covers your rear just as satellite navigation on the Subaru WRX Premium AWD keeps you heading in the right direction. Whatever you do, it'll never be boring.



**Infotainment system**  
Subaru WRX AWD



**Push-start ignition**  
All Subaru WRX variants



**Harman Kardon<sup>®2</sup> speakers**  
Subaru WRX Premium AWD



**Steering wheel controls**  
Lineartronic<sup>®</sup> CVT variants

1. Some parts of the seating or trim are not full natural leather.  
2. Harman Kardon<sup>®</sup> is a registered trademark of HARMAN International Industries, Incorporated.





**Subaru WRX  
Premium  
AWD (CVT)**

# be inspired

## Interior

On the inside Subaru WRX AWD features black cloth. Sumptuous black leather<sup>1</sup> is standard on Subaru WRX Premium AWD.



**Cloth**  
Black



**Leather**  
Black

## Exterior

The colour you choose for your Subaru makes a bold statement about who you are. So we've made sure you've got lots of ways to express yourself – with a wide range of colours to make your Subaru more... you.

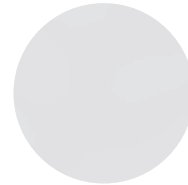

**Crystal White**  
Pearl

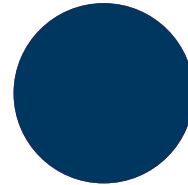

**Lapis Blue**  
Pearl

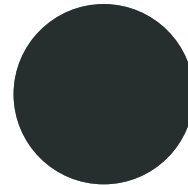

**Dark Grey**  
Metallic

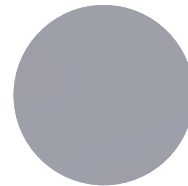

**Ice Silver**  
Metallic

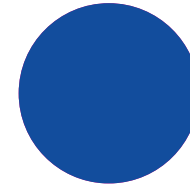

**WR Blue**  
Pearl

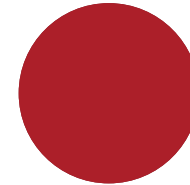

**Pure Red**

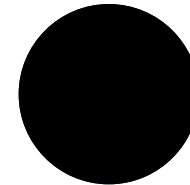

**Crystal Black**  
Silica

1. Some parts of the seating or trim are not full natural leather.

Note: Paint colours are representative only and subject to variation due to the printing process.

## Subaru WRX specifications<sup>1</sup>

MODEL	Subaru WRX AWD		Subaru WRX Premium AWD	
	Sedan		Sedan	
<b>Transmission</b>				
6-speed manual transmission		•		•
Sports Lineartronic® CVT		•		•
<b>Engine</b>				
Bore x stroke	mm	86.0 x 86.0		
Capacity	cc	1998		
Compression ratio		10.6:1		
Engine type		Direct Injection turbocharged horizontally-opposed Boxer 4-cylinder, petrol engine		
Fuel requirement (min)	RON	95		
Fuel system		Direct injection		
Fuel tank capacity	litres	60		
Valve mechanism		DOHC with Dual AVCS		
<b>Performance<sup>2</sup></b>				
CO <sub>2</sub> emissions (ADR 81/02)	combined	(g/km)	213 (MT) / 199 (CVT)	
Electronic Throttle Control system (ETC)			Drive-by-wire	
Fuel consumption (ADR 81/02) For comparison purposes only. Real world results may vary <sup>3</sup> :				
	combined	l/100 km	9.2 (MT) / 8.6 (CVT)	
	extra urban	l/100 km	7.2 (MT) / 6.8 (CVT)	
	urban	l/100 km	12.7 (MT) / 11.8 (CVT)	
Maximum power output (DIN)		kW/rpm	197kW@5600rpm	
Maximum torque (DIN)		Nm/rpm	350Nm@2400-5200rpm	
<b>Symmetrical All-Wheel Drive (AWD)</b>				
Type	Auto		Variable Torque Distribution	
	Manual		Centre Differential with a Viscous Limited Slip Differential	
<b>Transmission</b>				
Final reduction gear ratio			4.444 (MT) / 3.900 (CVT)	
Gear ratio	1st		3.454 (MT) / 3.505 (S#: 3.505) (CVT)	
	2nd		1.947 (MT) / 2.238 (S#: 2.405) (CVT)	
	3rd		1.366 (MT) / 1.641 (S# 1.855) (CVT)	
	4th		1.029 (MT) / 1.194 (S#: 1.544) (CVT)	
	5th		0.825 (MT) / 0.880 (S#: 1.258) (CVT)	

1. Subaru Australia reserves the right to change mechanical specification and equipment levels without notice. 2. All performance data measured using 95RON as required by Australian Design Rule 81/02. Vehicles tested in accordance with ADR 81/02. 3. Fuel consumption figures quoted are measured in accordance with Australian Design Rule 81/02 and are for comparison purposes only. Real world results may vary based on individual driving circumstances e.g. traffic conditions, driving style, vehicle conditions, fuel quality, climatic conditions etc. Quoted figures may not reflect real world fuel consumption.

## Subaru WRX specifications<sup>1</sup>

MODEL		Subaru WRX AWD	Subaru WRX Premium AWD
	6th	0.666 (MT) / 0.611 (S#: 1.032) (CVT)	
	7th	(S#: 0.856) (CVT)	
	8th	(S#: 0.716) (CVT)	
Gear ratio – reverse		3.636 (MT) / 2.345 (CVT)	
<b>Steering</b>			
Minimum turning circle		m 11.0	
Type		Electric power assistance rack and pinion	
<b>Suspension</b>			
Type		Front	MacPherson struts inverted, lower L-arms, coil springs, stabiliser bar
		Rear	Double wishbone, coil springs, stabiliser bar
<b>Brakes</b>			
ABS		4-channel, 4-sensor ABS with Electronic Brakeforce Distribution and VDC	
Brake booster type		Tandem	
Type		Front	Ventilated disc brakes
		Rear	Disc brakes (MT) / Ventilated disc brakes (CVT)
<b>Wheels and Tyres</b>			
Rim size		18x8.5J	
Spare wheel		Spacesaver wheel	
Tyre manufacturer		Dunlop SP Sport Maxx RT	
Tyres (width, profile, size, load index and speed rating)		245/40 R18 97W	
Wheels		18"	
<b>Measurement</b>			
Cargo volume		litres	460
Front track		mm	1530
Minimum ground clearance <sup>2</sup>		mm	135
Overall height		mm	1475
Overall length		mm	4595
Overall width		mm	1795
Rear track		mm	1540
Seating capacity		5	
Tare mass <sup>3</sup>		kg	1436 (MT) / 1494 (CVT)   1474 (MT) / 1532 (CVT)
Wheel base		mm	2650

1. Subaru Australia reserves the right to change mechanical specification and equipment levels without notice. 2. Ground clearance at kerb weight. 3. Vehicle tare mass varies according to the types of optional equipment included.

## Subaru WRX features<sup>1</sup>

MODEL	Subaru WRX AWD	Subaru WRX Premium AWD
<b>Safety Rating</b>		
5 star ANCAP <sup>2</sup> safety rating (maximum 5)	•	•
<b>Collision Avoidance</b>		
Symmetrical All-Wheel Drive (AWD)	•	•
4-wheel disc brakes	•	•
Auto Vehicle Hold (AVH)	CVT	CVT
Electronic parking brake	CVT	CVT
Hill Start Assist	MT	MT
Rear view reverse camera	•	•
Vehicle Dynamics Control system (VDC) featuring:	•	•
Active Torque Vectoring system	•	•
Anti-lock Braking System (ABS)	•	•
Brake Assist	•	•
Electronic Brakeforce Distribution (EBD)	•	•
Electronic Stability Control (ESC)	•	•
Traction Control System (TCS)	•	•
Vision Assist featuring:		•
Blind Spot Monitor (BSM)		•
EyeSight® Assist Monitor		CVT
Front View Monitor (FVM)		•
High Beam Assist (HBA)		•
Lane Change Assist (LCA)		•
Rear Cross Traffic Alert (RCTA)		•
Side View Monitor (SVM)		•
<b>Collision Protection</b>		
3 point A/ELR rear seat belts	•	•
Front seat belts with pretensioners and load limiters	•	•
Height adjustable rear seat headrests	•	•
Height adjustable seat belt anchors – driver and front passenger	•	•
Height and angle adjustable front seat headrests	•	•
Rear seat headrests for 3 seating positions	•	•
Ring-shaped passenger safety cell	•	•
Seat belt warning lights – all seats	•	•
SRS <sup>3</sup> airbags – dual front, dual front side and curtain	•	•
SRS <sup>3</sup> airbags – knee airbag (driver only)	•	•

1. Subaru Australia reserves the right to change mechanical specification and equipment levels without notice. 2. The Australasian New Car Assessment Program (ANCAP) gives consumers consistent information on the level of occupant protection provided by vehicles in serious front and side crashes. 3. SRS: Supplemental Restraint System. Effective when used in conjunction with seat belts.

## Subaru WRX features<sup>1</sup>

MODEL	Subaru WRX AWD	Subaru WRX Premium AWD
<b>Child Safety</b>		
Child seat anchor points (x3)	•	•
ISOFIX anchor points (x2)	•	•
Rear door child locks	•	•
<b>Intelligent Driving Dynamics</b>		
Cruise Control	MT	MT
Electronic Throttle Control system (ETC)	•	•
EyeSight® Driver Assist system featuring:		
Adaptive Cruise Control	CVT	CVT
Brake Light Recognition	CVT	CVT
Lane Departure Warning	CVT	CVT
Lane Keep Assist	CVT	CVT
Lane Sway Warning	CVT	CVT
Lead Vehicle Start Alert	CVT	CVT
Pre-Collision Brake Assist	CVT	CVT
Pre-Collision Braking System	CVT	CVT
Pre-Collision Steering Assist	CVT	CVT
Pre-Collision Throttle Management	CVT	CVT
Subaru Intelligent Drive (SI-Drive):	CVT	CVT
Intelligent (I) mode	CVT	CVT
Sport (S) mode	CVT	CVT
Sport Sharp (S#) mode	CVT	CVT
<b>Chassis and Mechanism</b>		
Clutch start system	MT	MT
Front and rear stabiliser	•	•
Rear Limited Slip Differential (LSD) (manual)	Torsen	Torsen
Tie-rod type tandem brake booster system	•	•
<b>Exterior</b>		
18" alloy wheels	•	•
Body coloured mirrors and door handles	•	•
Body coloured rear garnish	•	•
Bonnet scoop	•	•
Bonnet with gas struts	•	•
Detachable module type windscreen wipers	•	•
Door mirrors with indicators – heated and power-folding	•	•
Dual twin tail pipes with covers	•	•

1. Subaru Australia reserves the right to change mechanical specification and equipment levels without notice.

## Subaru WRX features<sup>1</sup>

MODEL	Subaru WRX AWD	Subaru WRX Premium AWD
Electric sunroof		•
Engine cover	•	•
Front wipers with de-icer		•
Fuel cap – tethered	•	•
Rear diffuser	•	•
Rear spoiler	•	•
Red brake calipers	Front and Rear (MT) / Front (CVT)	Front and Rear (MT) / Front (CVT)
Roof carrier brackets	•	•
Shark fin antenna	•	•
Side garnish with WRX logo	•	•
Side sill skirts	•	•
Spacesaver spare wheel	•	•
Sports mesh grille	•	•
Tail pipe covers	•	•
<b>Lighting – Exterior</b>		
Daytime Running Lights – LED	•	•
Front fog lights – LED	•	•
Headlights – dusk-sensing	•	•
Headlights – self-levelling LED headlights with auto off	•	•
Rear fog light	•	•
Rear LED combination lights	•	•
Rear LED stoplight	•	•
Steering Responsive Headlights (SRH)	•	•
<b>Lighting – Interior</b>		
Cabin and cargo area lights	•	•
Map lights (x2)	•	•
<b>Air-conditioning</b>		
Anti-dust filter	•	•
Dual zone climate control	•	•
Floor heater ducts for rear passengers	•	•
Front and side demisters	•	•
Rear windscreen demister – electric	•	•
<b>Security</b>		
DataDotDNA <sup>®2</sup> security system	•	•
Immobiliser security system	•	•

1. Subaru Australia reserves the right to change mechanical specification and equipment levels without notice. 2. DataDotDNA<sup>®</sup> is a theft deterrent not a theft prevention mechanism.



## Subaru WRX features<sup>1</sup>

MODEL	Subaru WRX AWD	Subaru WRX Premium AWD
<b>Instrumentation and Controls</b>		
Adjustable steering wheel – height and telescopic	•	•
Electroluminescent gauges with colour MID	•	•
Hazard warning indicators	•	•
Instrument cluster	•	•
Manual mode	CVT	CVT
One touch lane change indicator	•	•
Paddle gear shifters	CVT	CVT
Sports pedals	•	•
Steering wheel controls:	•	•
Audio	•	•
Bluetooth® <sup>2</sup>	•	•
Cruise	MT	MT
EyeSight®	CVT	CVT
MID	•	•
SI-Drive	CVT	CVT
Twin trip meter (switchable)	•	•
<b>Multi-Function Displays</b>		
MFD visor with red stitching	•	•
Multi-Function Display unit (MFD) featuring:	•	•
5.9" LCD screen	•	•
Air-conditioning and seat belt display	•	•
Front View Monitor display	•	•
Fuel economy and journey information	•	•
Outside temperature and clock display	•	•
Preventative Safety display	•	•
Side View Monitor display	•	•
Turbo boost pressure display	•	•
Multi-Information Display unit (MID) featuring:	•	•
3.5" LCD screen	•	•
Digital speedometer	•	•
Eco-gauge display	•	•
EyeSight® display	CVT	CVT
Journey information	•	•
SI-Drive display	CVT	CVT
Warning display	•	•

1. Subaru Australia reserves the right to change mechanical specification and equipment levels without notice. 2. Bluetooth® is a registered trademark of Bluetooth SIG Inc. System functionality is subject to the Bluetooth® wireless technology specification of individual device.

## Subaru WRX features<sup>1</sup>

MODEL	Subaru WRX AWD	Subaru WRX Premium AWD
<b>Storage</b>		
Centre console box with sliding armrest	CVT	CVT
Cupholders – centre console with sliding lid	CVT	CVT
Cupholders – rear	•	•
Door pockets with integrated bottle holder – front and rear	•	•
Front centre tray with WRX logo	MT	MT
Seat back pocket – driver and front passenger		•
Seat back pocket – front passenger	•	
<b>Convenience</b>		
12V/120W power jacks (x2)	•	•
Auto-dimming rear view mirror		•
Boot/tailgate unlock on remote central locking keys	•	•
Interior fuel lid lock release	•	•
Intermittent variable speed front windscreen wipers	•	•
Power mirrors and windows – all with auto function	•	•
Power steering	•	•
Rain-sensing front windscreen wipers	•	•
Remote central locking keys (x2)	•	•
Remote central locking – selective unlock	•	•
Smart key and push-start ignition	•	•
Sunvisors with illuminated vanity mirrors – driver and front passenger	•	•
<b>Interior Trims</b>		
Carpet trim – black	•	•
Leather steering wheel and gear shift	•	•
Seat trim – black cloth	•	
Seat trim – black leather <sup>2</sup>		•
Shift boot	CVT	CVT
Sports bucket seats with red stitching – driver and front passenger	•	•
<b>Seating Extras</b>		
60/40 split folding rear seats	•	•
8-way power seat with dual memory – driver		•
Electric lumbar support – driver		•
Heated seats - driver and front passenger		•

1. Subaru Australia reserves the right to change mechanical specification and equipment levels without notice. 2. Some parts of the seating or trim are not full natural leather.

## Subaru WRX features<sup>1</sup>

MODEL	Subaru WRX AWD	Subaru WRX Premium AWD
Manual seat height lifter – driver	•	
<b>Entertainment</b>		
Auxiliary jack – front centre console	•	•
Bluetooth <sup>®2</sup> wireless technology with:	•	•
Handsfree mobile communication	•	•
Audio streaming <sup>3</sup>	•	•
Integrated infotainment system featuring:	•	•
6 speakers	•	
6.5" LCD touchscreen	•	
7" LCD touchscreen		•
8 Harman Kardon <sup>®4</sup> speakers, subwoofer and amplifier		•
AM/FM radio	•	•
Apple CarPlay <sup>®</sup> and Android Auto <sup>™</sup> connectivity <sup>5</sup>	•	•
Digital radio <sup>6</sup> (DAB+)	•	•
Satellite navigation		•
Single CD player	•	•
Siri <sup>®7</sup> compatibility		•
USB connections – front centre console	x1	x2
Voice command recognition	•	•
<b>Owner Benefits</b>		
5 Year/Unlimited Km Warranty	•	•
5 Year/125,000 Km Capped Price Servicing Program <sup>8</sup>	•	•
12 Month Roadside Assistance Program <sup>9</sup>	•	•

1. Subaru Australia reserves the right to change mechanical specification and equipment levels without notice. 2. Bluetooth<sup>®</sup> is a registered trademark of Bluetooth SIG Inc. System functionality is subject to the Bluetooth<sup>®</sup> wireless technology specification of individual device. 3. There may be restrictions on features available for certain models that are not fully compliant with AVCRP. 4. Harman Kardon<sup>®</sup> is a registered trademark of HARMAN International Industries, Incorporated. 5. Compatible Apple<sup>®</sup> or Android<sup>™</sup> device required. 6. Digital radio station coverage dependent on vehicle location. 7. Requires compatible Siri<sup>®</sup> enabled Apple<sup>®</sup> device to be paired with the infotainment system. 8. Every eligible Model Year 2018 onward Subaru WRX comes with Subaru's 5 Year/125,000 Km Capped Price Servicing Program. Available at participating Subaru Retailers only and does not apply to rental and some other classes of vehicles. For full Capped Price Servicing Terms and Conditions visit [www.subaru.com.au/service/pricing/capped-price-servicing](http://www.subaru.com.au/service/pricing/capped-price-servicing). 9. 12 Month Roadside Assistance Program is standard upon activation with relevant Motoring Club in each state. To receive this benefit the customer must opt into the 12 Month Roadside Assistance program at time of vehicle delivery. Eligible customers are those retail and novated lease customers who purchase a new Subaru on or after 1st June 2013 and have less than 5 vehicles under the Club Membership offer. Customers must provide a valid phone and residential address, as well as date of birth. Fleet, Government and Rental companies are excluded.

# the excitement machine, made even more exciting

Your Subaru WRX handles as much excitement as you can throw at it. No matter the adventure, we've got some good kit to go with it. Style it up, spec it up and experience more with sports inspired Genuine Subaru Accessories designed to Subaru's exacting standards.

- + Protection      Protect your Subaru WRX with a range of products including carpet mats, a cargo tray, cargo cover and rear bumper protector.
- + Cargo            To extend your Subaru WRX's carrying capacity we offer a broad range of Subaru and Thule sport and cargo carrier accessories.
- + Security, Convenience and Safety      Keep your new wheels secure with a security car alarm system. The compact, windscreen mounted Garmin Dash Cam records sharp video; gives the driver a range of alerts and can be synced to your smartphone.
- + STI Performance Parts      Tweak the performance of your new Subaru WRX for that extra edge. Emphasise the beast with performance parts for optimum handling and control. Or spiff it up with aerodynamic spoilers.

Genuine Subaru Accessories are available from your Subaru Retailer, so be sure to ask about the range when buying your new Subaru WRX.

 To view our complete range of accessories and pricing online visit [subaru.com.au/wrx/accessories](https://subaru.com.au/wrx/accessories)



# packs that will inspire you



a

From coastal adventures to nights out in the city, this quality Genuine Subaru Accessory Pack will add a stylish flare like no other and give you the versatility you desire to stand out with your Subaru WRX.



b

Both stylish and functional, each Styling Pack<sup>1</sup> accessory has been custom made for a tailored fit to complement your Subaru WRX and keep it looking good for years to come.

Plus all Genuine Subaru Accessories are protected by our manufacturer's warranty<sup>2</sup>.

## Styling Pack<sup>1</sup> includes:

### a STI Front Under Spoiler

Do corners and open road driving with more confidence, stability and handling, while adding stylish appeal.

### c STI Rear Side Under Spoiler

Have some fun and finish first with sporty design detail for every last inch of your Subaru WRX.

### b STI Side Under Spoiler

Enhance the stylish silhouette of your Subaru WRX with this sleek side spoiler designed to complement the vehicle's bodyline.

### d STI Rear Under Spoiler

Complete the picture with this rear under spoiler which improves overall vehicle aerodynamics and adds an aggressive, dynamic look.



c



d

1. Adding Styling Pack will lower ground clearance.

2. For full warranty terms and conditions, visit [subaru.com.au/accessories-information/warranty](https://subaru.com.au/accessories-information/warranty)

# protect your investment

Do more while protecting your Subaru WRX from the rough and tumble of daily life. From carpet mats to a rear bumper protector, each of the below accessories are tailored for a perfect fit.

ACCESSORY	Part Number	Subaru WRX AWD	Subaru WRX Premium AWD
<b>Styling</b>			
1 Side Sill Plate (Non-illuminated)	E101SVA000	•	•
2 Exhaust Surround	E7710VA700	•	•
<b>Protection</b>			
3 Carpet Mat Set	J501AVA201	•	•
4 Car Cover	M001SFJ000	•	•
5 Body Side Moulding (Painted)	J101SFJ000##	•	•
6 Weather Shields	E3610FJ800	•	•
7 Bootlip and Bumper Protector	SAT6003	•	•
<b>Cargo and Tow</b>			
8 Roof Cross Bars	SAT3015	•	•
9 Roof Cross Bars – Wingbar Edge (Black)	SAT3016	•	•
10 Cargo Tray	J501SFJ400	•	•

## Denotes colour option of your choice.

 To view our complete range of accessories and pricing online visit [subaru.com.au/wrx/accessories](http://subaru.com.au/wrx/accessories)

•

Not Applicable  
Applicable





11



12

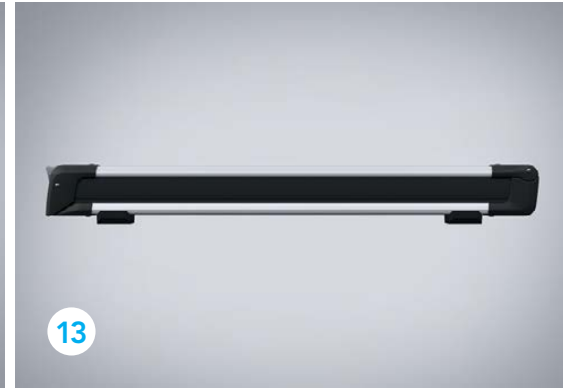

13

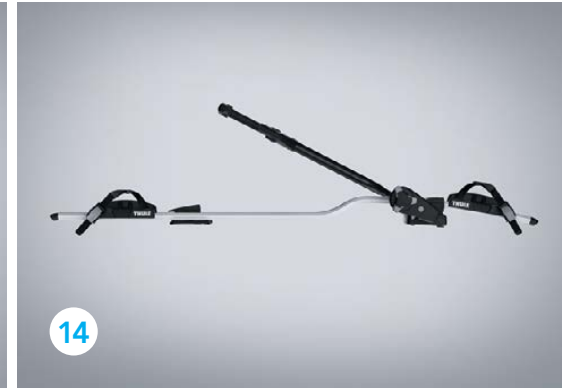

14



15



16

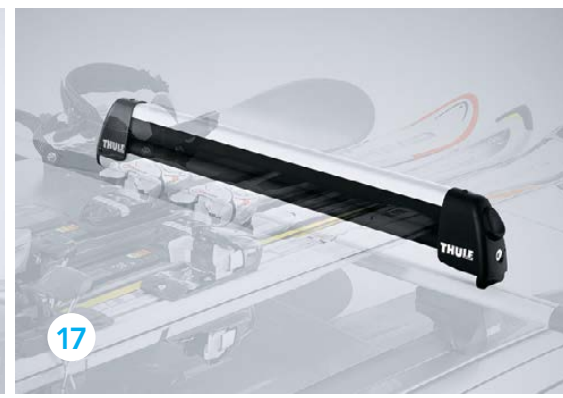

17



18



19



20



21



22



23

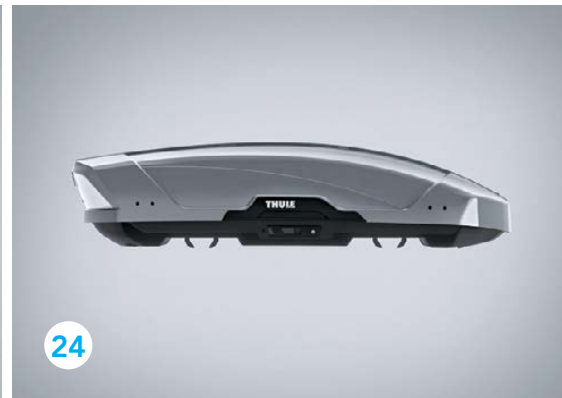

24



25





# pack it all in

Get out amongst it and pack more into your weekends with premium quality accessories that let you effortlessly take all your gear with you.

ACCESSORY	Part Number	Subaru WRX AWD	Subaru WRX Premium AWD
<b>Thule Roof Attachments and Accessories (Roof Cross Bars Required)</b>			
11 Xtender 6 Pair Ski Holder	SA1156	•	•
12 Deluxe Ski Carrier – 4 Pair	SAT8023	•	•
13 Deluxe Ski Carrier – 6 Pair	SAT8024	•	•
14 Bicycle Holder – Silver (Upright)	SAT8018	•	•
15 Bicycle Holder – Black (Upright)	SAT8019	•	•
16 Bicycle Holder (Fork Mounted)	SA1042	•	•
17 Ski Holder – 4 Pair	SAT9012	•	•
18 Ski Holder – 6 Pair	SAT9013	•	•
19 Surfboard Carrier	SA1139	•	•
20 Kayak Carrier – Dockglide	SAT9018	•	•
21 Thule Paddleboard & Mal Carrier	SAT8016	•	•
22 Luggage Pod Touring 100 (Titan Aeroskin) Textured Finish (Small)	SAT5008	•	•
23 Luggage Pod Touring 100 (Black Glossy) Smooth Finish (Small)	SAT5008B	•	•
24 Luggage Pod Motion XT M (Glossy Silver)	SAT9014	•	•
25 Luggage Pod Motion XT M (Glossy Black)	SAT9015	•	•

 To view our complete range of accessories and pricing online visit [subaru.com.au/wrx/accessories](https://subaru.com.au/wrx/accessories)

ACCESSORY		Part Number	Subaru WRX AWD	Subaru WRX Premium AWD
<b>Thule Roof Attachments and Accessories (Roof Cross Bars Required)</b>				
26	Thule Go Box	SAT8005	•	•
27	Thule Go Pack Set (4 Bags)	SAT8006	•	•
28	Side Up Wheel Step	SAT9004	•	•
<b>Security</b>				
29	Wheel Lock Nuts	B327EYA000	•	•
30	Security Alarm System (Push-Start)	H771AVA700	•	•
<b>Convenience and Safety</b>				
31	Round Type Ashtray (Black)	92172AG040	•	•
32	Cigarette Lighter	H6710FJ000	•	•
33	Ash Tray Holder	F6010AG010	•	•
34	Arm Rest Extension (Manual Only)	J2010AG000JD	•	•
35	First Aid Kit	PR7670	•	•
36	Safety Triangle	SAT9007	•	•
37	Garmin Dash Cam 55	0100175011	•	•
38	Magnetic Mount (additional)	0101253000	•	•

26



27



28



29



30



31



32



33



34



35



36



37

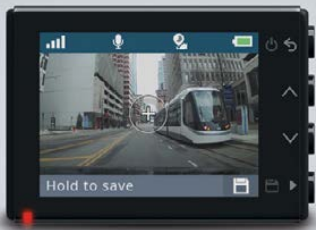

38





# kick it into overdrive

Up the ante on your Subaru WRX by enhancing its street appeal, cockpit aesthetics and driver dynamics with STI branded performance parts.

ACCESSORY	Part Number	Subaru WRX AWD	Subaru WRX Premium AWD
<b>STI Performance Parts</b>			
39 Flexible Tower Bar	ST20502VV030A	•	•
40 Short Throw Shifter	C1010VA010	•	•
41 Push-Start Engine Switch (Red)	ST83031ST040	•	•
42 STI Leather Shift Knob (CVT)	C1010SG101	•	•
43 STI Leather Shift Knob (6MT)	C1010FG100	•	•
44 STI Front Under Spoiler <sup>1</sup>	E2410VA030	•	•
45 STI Side Under Spoiler <sup>1</sup>	E2610VA000	•	•
46 STI Rear Side Under Spoiler <sup>1</sup>	E5610VA000	•	•
47 STI Rear Under Spoiler <sup>1</sup>	E5610VA120	•	•
48 Security Wheel Nut Set	ST28170ST060	•	•
49 Valve Cap Set	ST28102ST030	•	•
50 Battery Clamp/Holder	ST82182ST000	•	•
51 High Pressure Radiator Cap	ST4511355010	•	•
52 Sports Oil Filter	ST15208ST010	•	•
53 Oil Cap	ST15257ZR010	•	•

1. Will reduce ground clearance.

 To view our complete range of accessories and pricing online visit [subaru.com.au/wrx/accessories](https://subaru.com.au/wrx/accessories)

# welcome to the family

There are cars that simply get you from A to B, and then there are cars that empower you. Buying a Subaru is like embracing life with both hands and knowing that nothing is going to stop you. When you buy a new Subaru you



are welcomed into an owner's program that gives you access to a number of benefits.

## Subaru New Car Warranty – 5 Year/Unlimited Kilometres

Every new Subaru purchased on or after 1st January 2019 is covered by a 5 Year/Unlimited Kilometre manufacturer's national warranty. Visit [subaru.com.au/warranty](http://subaru.com.au/warranty) or ask your Subaru Retailer for more information.

## Subaru Capped Price Servicing

With our Subaru 5 Year/125,000 Kilometre Capped Price Servicing Program<sup>1</sup>, you'll now know the maximum amount you will have to pay for your next scheduled service during

the Program period. You'll also have peace of mind knowing that specialist Subaru technicians will be looking after your pride and joy using only Genuine Subaru Parts.



## DataDotDNA®

Every Subaru is fitted with advanced engine immobilisers and the DataDotDNA<sup>®2</sup> Theft Deterrent System. Microscopic dots are laser-etched with each vehicle's unique Vehicle Identification Number – making it a less attractive target for thieves.

## Three Year Rebate on Theft Insurance Excess

DataDot Technology (Australia) Pty Ltd will pay your theft insurance excess<sup>3</sup> (up to a maximum of \$800 including GST) should your new Subaru be stolen in the first three years of purchase and not recovered within 45 days despite the presence of DataDotDNA<sup>®2</sup> and warning labels.

## 1-Month Health Check and Chat

The 1-Month Health Check and Chat is a free consultation within the first month after delivery of your new Subaru. It allows our factory-trained technicians to provide quick vehicle checks, and one of our Service Advisors will answer any of your questions to help ensure an ongoing, worry-free experience.

## Subaru's Map Updates

If your new Subaru is fitted with a factory line fit navigation unit your unit will be covered by Subaru's Map Update Program<sup>4</sup> – guaranteeing you'll have access to the latest maps for the first 3 years of ownership.

## My Subaru – online owner's destination

The My Subaru owner's portal is an online destination for owners which provides access to exclusive benefits, tailored content, your vehicle's ownership history and much more.

1. Every eligible Model Year 2018 onward Subaru WRX comes with Subaru's 5 Year/125,000 Km Capped Price Servicing Program. Available at participating Subaru Retailers only and does not apply to rental and some other classes of vehicles. For full Capped Price Servicing Terms and Conditions visit [www.subaru.com.au/service/pricing/capped-price-servicing](http://www.subaru.com.au/service/pricing/capped-price-servicing). 2. DataDotDNA<sup>®</sup> is a theft deterrent not a theft prevention mechanism. 3. Vehicles must be registered, comprehensively insured and less than 3 years old. DTA must receive a claim within 45 days of the theft. Terms and conditions apply. 4. Subaru's Map Update Program is available on MY19 Subaru WRX variants purchased from 30th July 2018 onwards with the factory line fit Gen3.1 navigation unit. Subaru's Map Update Program is not available on accessory fit or dealer sourced navigation units. For full terms and conditions of the Subaru Map Update Program visit [www.subaru.com.au/owner-experience/benefits/subaru-map-update-program](http://www.subaru.com.au/owner-experience/benefits/subaru-map-update-program).

# live life without limits

Login to My Subaru, the online destination for Subaru owners that will help you get more out of your vehicle, and more out of your life.

Visit [my.subaru.com.au](https://my.subaru.com.au)

## Subaru Roadside Assistance

Enjoy 12 months of Australia-wide, standard Roadside Assistance when you purchase your new Subaru. In the unfortunate situation where you need that extra helping hand, our Roadside Assistance will help<sup>1</sup> with arranging a tow, battery service, flat tyre service, fuel delivery and lockout service.

## Subaru Certified Collision Repairer Network

With a dedicated Subaru Certified Collision Repairer<sup>2</sup> helpline available on 1800 737 179, help is available when you need it most. Available 24-hours a day, 7 days a week, help is only a phone call away. Subaru Certified Collision Repairers guarantee that trained specialists will repair your Subaru to strict factory specifications using Genuine Subaru Parts.

## Genuine Accessories

Genuine Subaru Accessories are designed to enhance your vehicle, help you get more stuff done and have more fun! Our genuine accessories are factory approved by Subaru and are protected by the Genuine Subaru Accessories Warranty. For our full range of Subaru WRX accessories visit [subaru.com.au/wrx/accessories](https://subaru.com.au/wrx/accessories). For warranty information visit [subaru.com.au/warranty](https://subaru.com.au/warranty) and click on "Genuine Subaru Accessories Warranty".

## Subaru Finance

Subaru Finance<sup>3</sup> provides a range of competitive financial solutions to approved customers. Our finance specialists will help you find a finance package to meet your needs conveniently.

## Subaru Insurance

It's important to enjoy the freedom of owning a Subaru, but it's also important to protect it. A range of Subaru Insurance<sup>4</sup> options provides a variety of choices, including: Subaru Comprehensive Motor Vehicle Insurance and Subaru Loan Protection Insurance.

## Subaru Certified Used Cars

Every Subaru Certified Used Car has passed a 120-point quality inspection and comes with a one year unlimited kilometre Subaru Assured Warranty<sup>5</sup> – to complement the balance of a new vehicle warranty or the statutory warranty that remains – from participating Subaru Certified Used Car Retailers.

1. 12 month Club Membership and Roadside Assistance Offer is standard upon activation with the relevant Motoring Club in each state. To receive this benefit the customer must opt into the 12 month Club Membership and Roadside Assistance Offer at time of vehicle delivery. Eligible customers are those retail and novated lease customers who purchase a new Subaru and have less than 5 vehicles under the Club Membership offer. Customers must provide a valid phone number and residential address, as well as date of birth. Fleet, Government and Rental companies are excluded. Terms and conditions apply. For a full list of benefits, visit [www.subaru.com.au/owner-experience/benefits/program/roadside](https://www.subaru.com.au/owner-experience/benefits/program/roadside). 2. Subaru Certified Collision Repairer network not available in all areas. Call 1800 737 179 or visit [www.subaru.com.au/retailers](https://www.subaru.com.au/retailers) to find your closest Subaru Certified Collision Repairer. 3. Finance provided by Macquarie Leasing Pty Limited ABN 38 002 674 982 Australian Credit Licence Number 394925 trading as Subaru Finance. All applications for credit are subject to Macquarie's normal credit approval criteria. Terms and conditions, fees and charges apply. 4. Subaru Insurance products are issued by Allianz Australia Insurance Limited AFS Licence No. 234 708 ABN 15 000 122 850 (Allianz). In arranging this insurance Subaru (Aust) Pty Limited ABN 95 000 312 792 (Subaru) and the authorised dealers act as agents of Allianz and not as your agent. Neither Subaru nor any of its related companies or appointed authorised retailers have any liability in respect of these policies. 5. The Subaru Assured Warranty product is issued by the selling Subaru Retailer. Subaru Australia has no liability in respect of this warranty.

## Subaru WRX Awards

- 2014 - Australasian New Car Assessment Program 5 star ANCAP safety rating
- 2011 - Australasian New Car Assessment Program 5 star ANCAP safety rating for the entire Impreza range
- 2009 - MOTOR Magazine, Bang For Your Bucks Winner, Subaru Impreza WRX
- 2008 - International Engine of the Year Award, 2.0 – 2.5-litre class, Subaru Impreza WRX (2.5-litre turbocharged horizontally-opposed Boxer engine)
- 2007 - Australasian New Car Assessment Program 5 star ANCAP safety rating for the entire Impreza range
- 2006 - International Engine of the Year Award, 2.0 – 2.5-litre class, Subaru Impreza WRX (2.5-litre turbocharged horizontally-opposed Boxer engine)
- 2005 - International Association of Autotheft Investigators (IAATI), Outstanding Achievement in the Reduction of Motor Vehicle Theft in Australia, Subaru Impreza WRX
- 2004 - Australia's Best Cars, Best Sports Car 2004 under \$57,000, Subaru Impreza WRX
- 2003 - Australia's Best Cars, Best Sports Car 2003 under \$57,000, Subaru Impreza WRX
- 2001 - Australia's Best Cars, Best Sports Car under \$56,000, Subaru Impreza WRX
- 2000 - Wheels Car of the Year, Subaru Impreza
  - QLD Car of the Year Awards, Outstanding Compact Car, Subaru Impreza
  - Car of the Decade, Car Magazine UK, Subaru Impreza WRX
  - Gold Medal in Sports/Performance Car Category, Which Car, Australia, Subaru Impreza WRX
- 1999 - Best Sports Car under \$56,000, NRMA/RACV, NSW & VIC, Subaru Impreza WRX

Subaru Australia reserves the right to vary vehicle specifications and standard features in Australia from those detailed in this brochure. Vehicles shown in this brochure may be fitted with accessories available at additional cost. No part of the brochure can be reproduced without written permission from Subaru Australia. Printed in Australia.

[subaru.com.au](http://subaru.com.au)



**SUBARU**

© Copyright 2018 – Subaru (Aust) Pty Limited. All rights reserved.

Subaru (Aust) Pty Limited ABN 95 000 312 792 (Subaru Australia) PO Box 8311, Norwest NSW 2153 Toll Free: 1800 226 643